

ecostrad

INSTRUCTION MANUAL

Sunglo Infrared Heater with Remote

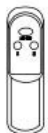
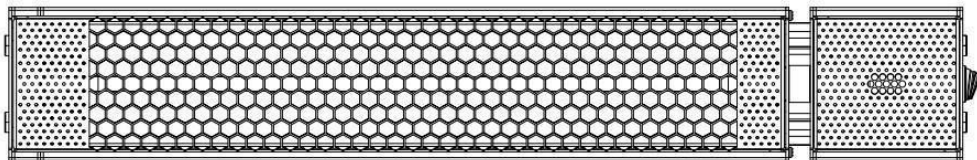

Ratings: AC 220-240V, 50/60Hz,
2000w, Class I, IP65 Rating

CE UK
CA

Symbols



Warning

This symbol indicates a hazard with an average risk level which, if not avoided, could result in serious injury or death.



Warning of electrical voltage

This symbol indicates danger to the life and health of persons due to electrical voltage.



Do not cover

This symbol located on the device indicates that it is prohibited to place objects (such as towels, clothes etc.) above or directly in front of the device. To avoid overheating and fire hazards, the device must not be covered.



Hot surface

This symbol located on the device indicates that its surfaces are hot during and immediately after operation. Hot surfaces should not be touched: danger of burns.



Observe instructions in manual

This symbol located on the device indicates that instructions in the operating manual must be observed when installing and using the device.

Contents

- 1 | About the Device
- 2 | Technical Information
- 3 | Warnings & Precautions
- 4 | Installation
 - 4-1 Installation Restrictions
 - 4-2 Fixings
 - 4-3 Mounting Instructions
 - 4-4 Installation with Stand
- 5 | Operation
 - 5-1 Power Switch
 - 5-2 Remote Control
 - 5-3 Insert Batteries
- 6 | Maintenance
- 7 | Cleaning
- 8 | Troubleshooting
- 9 | Warranty
- 10 | Disposal

1 | About the Device

The ECOSTRAD SUNGLO infrared heater contains a 'Helen lamp' reflector heating system that provides even heat distribution. The energy consumption of this infrared heater is 30 - 40% more efficient in comparison to traditional electric alternatives. Infrared heaters are ideal for indoor or outdoor spot heating and are perfect for garages, outdoor patios, and workshops.

2 | Technical Information

| | |
|--------------------|------------------------|
| Voltage | 220-240V AC / 50-60 Hz |
| Wattage | 2000W |
| Dimensions (WxHxD) | 680x110x70mm |
| Weight | 1.8kg |

3 | Warnings & Precautions

Read these instructions carefully before using or installing the heater. Retain the manual in the vicinity of the heater for future reference. The manufacturer cannot be liable for damages caused by failure to observe these instructions.







Warning

This infrared heater is designed for safe operation. Nevertheless, installation, maintenance and operation of the heater can be dangerous if performed incorrectly. Observing the following procedures will reduce the risk of fire, electric shock, and injury to persons, and will keep installation time to a minimum.

1. Carefully read the safety instructions before using this heater.
2. Remove the unit from its packaging and check to make sure it is in good condition before using.
3. Do not let children play with parts of the packaging (such as plastic bags).
4. Check household voltage to ensure it matches the heater's rated specification.
5. Check the plug and power cord carefully before use to make sure they are not damaged.
6. Before unplugging the power cord, be sure to turn off the power. Always ensure your hands are dry when operating the unit to prevent electric shock.



7. Do not use the heater near flammable objects such as furniture, pillows, bedding, paper, clothes, etc. Curtains must be kept at least 1m from the front of the heater, although for safety, any curtains or drapes should be kept toward the heater's rear or sides. Do not point the heater toward flammable objects.
8. Do not operate the heater within the immediate vicinity of a bath or swimming pool or any source of liquid.
9. To protect against electric shock, do not immerse the cord or plug in water or any other liquid. 
10. Do not insert or allow foreign objects to enter any ventilation openings, as this causes damage to the heater and increases the risk of fire or an electric shock.
11. Always unplug the heater when not in use.
12. Do not allow the cord to overhang any counter top where it can be easily pulled by children.
13. Always position the appliance with the mains plug in an accessible position and avoid the use of an extension cables as they may overheat and create a fire risk. 
14. If an extension cable is used, ensure you select a cable which is rated to support the heater's load. Extension cables that are rated too low to support the combined power of the appliances plugged into them can overheat and pose a fire risk.
15. Do not put fingers or foreign objects into the grill while in operation.
16. Do not leave the appliance unattended when in use.
17. This heater is not intended for use in bathrooms, laundry rooms and similar indoor locations. Never install the heater in a location where it may fall into a bathtub or other water container.
18. No liability can be accepted for any damage caused by non-compliance with these instructions or any other improper use or mishandling.
19. This appliance is not intended for use by persons (including children) with reduced physical, sensory or mental capabilities, or by inexperienced persons unless they have been given supervision or instruction concerning the use of the appliance by a person responsible for their safety. Children and vulnerable people should be supervised to ensure they do not play with the appliance.
20. If the supply cord is damaged in any way, it must be replaced by the manufacturer or its service agent or a similarly qualified person in order to avoid a hazard. 
21. To prevent the overheating of this appliance, keep the air inlets and outlets clean and free of anything that may cause blockage. Check all inlets and outlets from time to time to ensure they are clear of any dirt or dust accumulation. **Do not cover.** 

22. Parts of the heater may exceed 200 °C. Contact with the heating tube, reflector, or metal parts near the heating tube, **may cause severe burns**. Do not let bare skin come into contact with the hot surfaces of the heater.



23. Never place hands under the heating elements. Always allow the heating element to cool for at least 10 minutes before touching the heating tube or any adjacent parts.

24. This product contains recyclable materials. Do not dispose of this product with regular household waste. Please contact your local authority for collection and disposal information.

4 | Installation

4 – 1 Installation Restrictions

1. This heater should be installed by a competent person – i.e., a qualified electrician.
2. Always disconnect the heater from the electrical supply and allow it to cool before installation.
3. Do not install the heater on a flammable surface.
4. The heater must be kept a minimum of 1m away from people, animals, and flammable materials such as wood, cardboard and cloth.
5. The lowest part of the heater must be located at or above a minimum height of 1.8m from ground level, so that the heater cannot be touched when in operation.
6. Before drilling, ensure that there are no wires or water pipes in the area where the heater is to be installed.
7. The heater should be mounted a minimum of 0.4m away from the ceiling and adjacent walls.

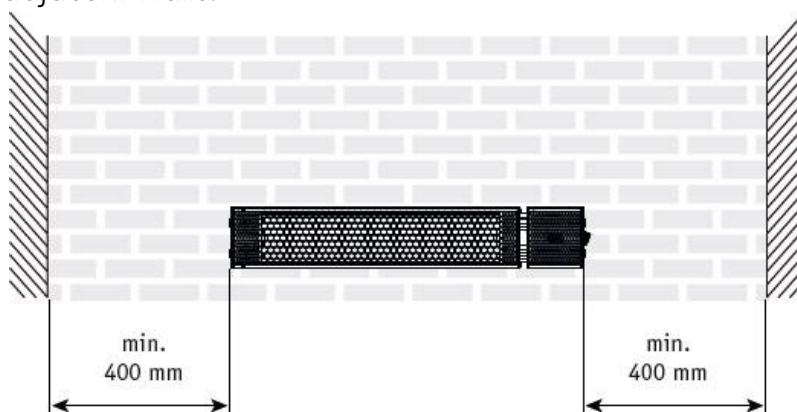
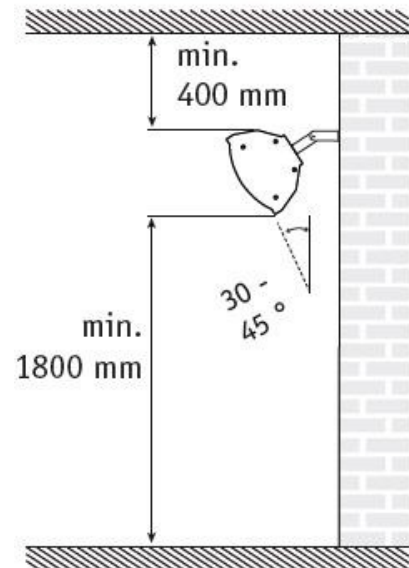

8. Keep the supply cord away from the body of the heater, which will get hot during use.
9. If the heater is to be used outside, a weatherproof outlet is recommended.
10. The heater must be installed on the mounting bracket provided. The heater should be angled between 135° and 180° from the mounting surface.
11. The heater must be mounted horizontally level.

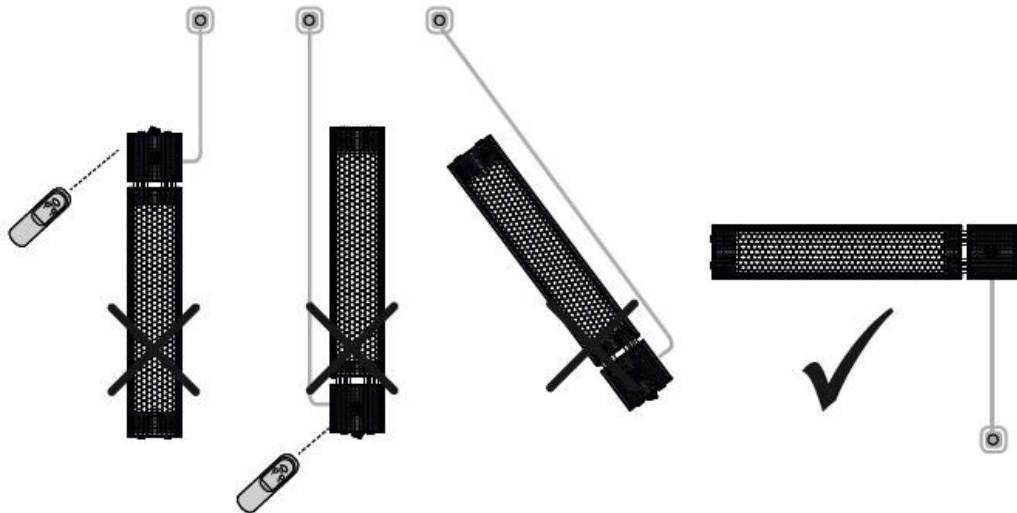
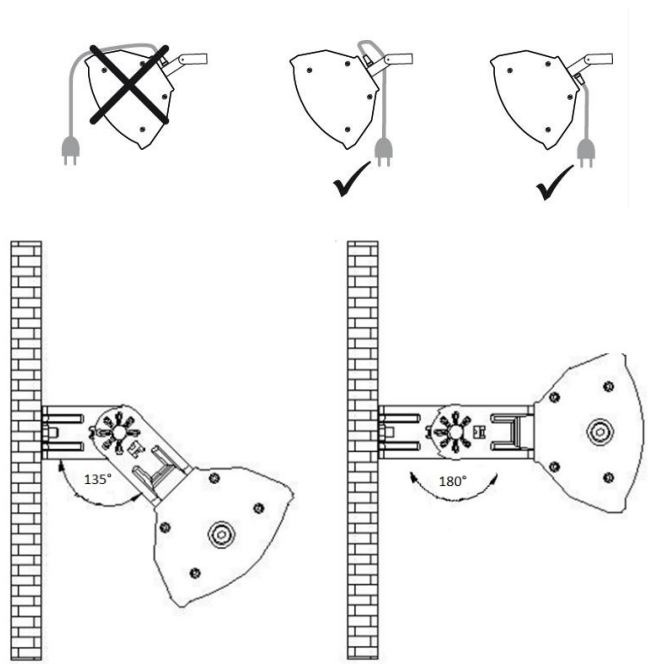

4 – 2 | Fixings

Before beginning installation, check that all fixings are supplied.

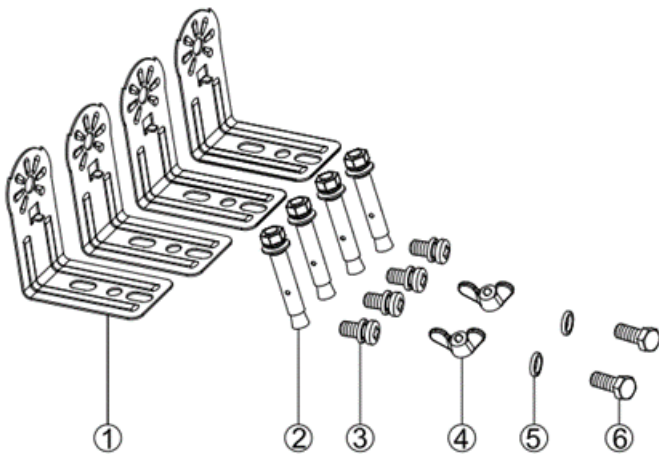

| Key | Fixing | Description | Qty |
|-----|----------|-------------|-----|
| 1 | Bracket | L-shaped | 4 |
| 2 | Bolt | M6mm*60mm | 4 |
| 3 | Screw | M5mm*10mm | 4 |
| 4 | Wing Nut | M6mm | 2 |
| 5 | Washer | Ø6mm*1mm | 2 |
| 6 | Screw | M6mm*12mm | 2 |

4 – 3 | Mounting Instructions



Important – Ensure the cable is well secured so that it does not trail into the heated area or come into contact with the reflector. The cable can be fixed to the metal mounting bracket behind the heater with plastic zip ties.

The mounting bracket provided with the heater has been specifically designed to allow the product to be fitted to a wall or ceiling. Before drilling the holes for the wall or ceiling mount, please ensure that the surface is solid and that there are no hidden water pipes or electrical wires. The heater must be installed no less than 0.4m from any side walls and no less than 1.8m from the floor.

Tools Needed:

- Pencil
- Hammer
- Spirit level
- Screwdriver
- Power drill and drill bits

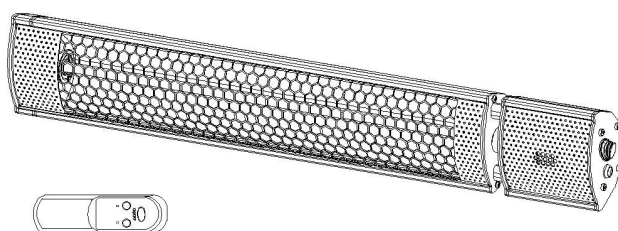

1. Fasten the brackets (1) together using the screws (6), washers (5) and wing nuts (4). (See Fig 1-2).
2. Line up the brackets with the wall or ceiling and mark the location of the four outer holes. Drill holes at the marked locations and fit the bolts (2) into the holes.
3. Thread the brackets over the bolts and fix securely to the mounting surface.
4. Fasten the heater securely to the brackets using the screws (3).
5. The brackets can be used to adjust the angle of the heater. Adjust the heater angle by loosening the wing nuts and tighten the bolts again when the desired angle is reached.

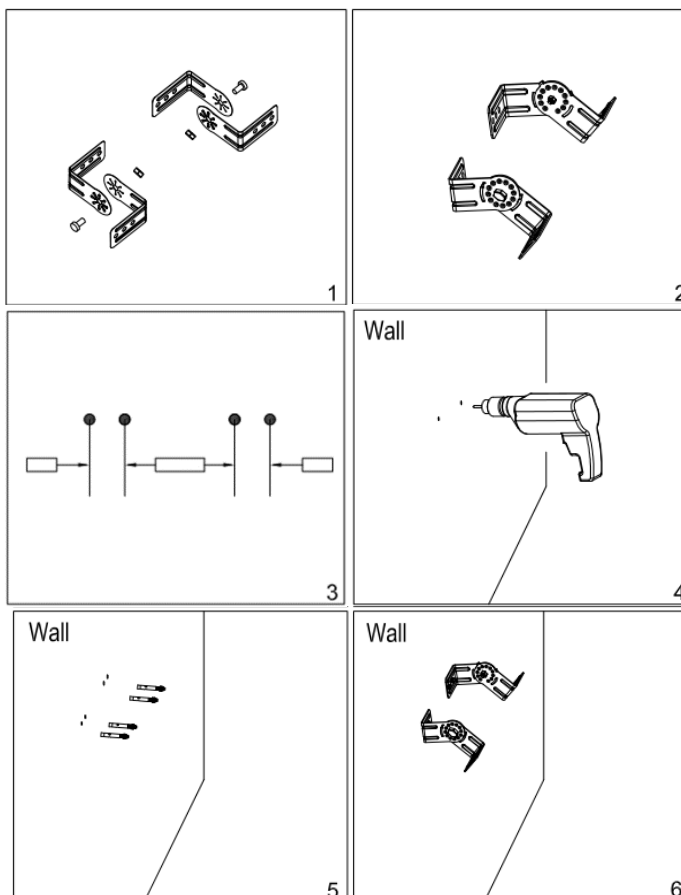

4 – 4 | Installation with Stand (Optional)

The heater can be purchased with an optional stand. Fit the heater on the stand as per the instructions below. (Fittings supplied with stand. Stand sold separately.)

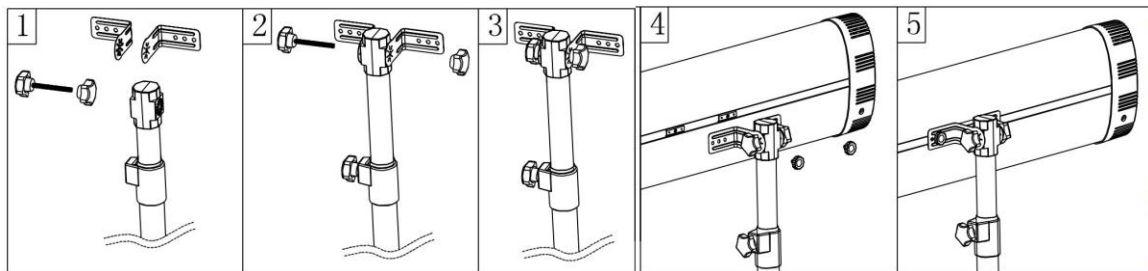

5 | Operation

5 – 1 | Power Switch

Plug the unit into a plug socket with power supply suitably rated for the appliance. Use the power button on the right side of the heater to switch the device on and off.

5 – 2 | Remote Control

All Ecostrad Sunglo heaters and their remote controls operate on the same frequency, allowing multiple heaters to be controlled with one remote.

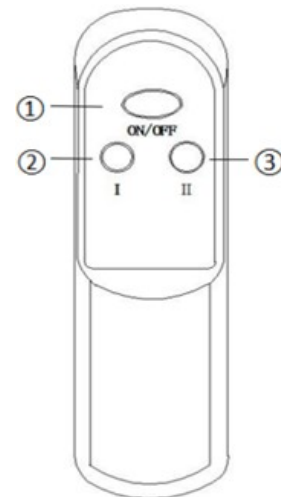

Remote Functions

1. Power – Turns the heater on and off.
2. Heat Level 1 – Change to 1000W power level.
3. Heat Level 2 – Change to 2000W power level.

5 – 3 | Insert Batteries

The remote requires 2 x AAA alkaline batteries for operation.

1. Turn over the remote and remove the battery cover.
2. Insert the batteries according to their polarity, as indicated in the battery slot.
3. Replace the battery cover.

Ensure expired batteries are replaced with batteries of the same type, or the remote may not function properly. If the heater is due to be out of use for a long period, remove the batteries to prevent leakage into the electronics. Do not allow water or other liquids to infiltrate the remote control.

6 | Maintenance

Careful and regular maintenance of the heater according to the instructions below is required to maximise the longevity and efficiency of your appliance.

- Check the cleanliness of the heater at least once a month. If needed, follow the cleaning instructions below. If the heater is being used in a dusty environment, the number of checks should be increased.
- Check the reflector, grille and frame for deformation visually while cleaning the appliance. If deformity is found, consult a qualified technician.
- Check the power cable and plug visually while cleaning the appliance. In case of any deformation, consult a qualified technician.

The heater should be switched off and unplugged from the socket if:

- You intend not to use the heater for a prolonged period of time.
- You want to change the location of the heater.
- Cleaning or maintenance is being conducted.

7 | Cleaning

Regular and careful cleaning will keep your heater operating efficiently for many trouble-free years.

1. Unplug the heater power cable and wait for the heater to cool down before cleaning your appliance. This is essential for your safety. 
2. The heater's outer casing may be cleaned with a soft, damp cloth. You may use a mild detergent if necessary. CAUTION: do not let liquids enter the heater.
3. After cleaning, dry the unit with a soft cloth.
4. Do not use alcohol, petrol, abrasive powders, furniture polish, or rough brushes to clean the heater. This may cause damage or deterioration to the surface of the heater.
5. Do not immerse the heater in water to clean.
6. Wait until the unit is completely dry before next use.
7. Store the heater in a cool, dry location when not in use to prevent dust and dirt build up. Use packaging carton to store.

NOTE – damage incurred by use of your heater in an unclean state is not covered by the warranty. Products returned in a dirty state will not be refunded or replaced.



Warning

- Always disconnect the heater from the electricity supply and allow it to cool before beginning work on it.
- If the heater has collected dust or dirt inside the casing or around the heating element, the unit must be cleaned by a qualified service agent. Do not operate the heater in this condition. The only user maintenance required is cleaning of the heater's external surfaces.
- Do not touch the heating element with bare fingers, as residue from touch could affect the lifespan of the lamp. If the bulb is accidentally touched, remove the finger marks with a soft cloth moistened with mentholated spirit or alcohol.
- Do not attempt to repair or adjust any electrical or mechanical functions on this heater.
- The heater contains no user serviceable parts. Should the product suffer damage or breakdown, it must be returned to the manufacturer or its service agent to avoid hazard. This includes damaged supply cords.

8 | Troubleshooting

If the device is not heating, follow the steps below:

1. Check if the power cord is plugged into an electrical outlet. If not, plug in.
2. Check if there is power supplied to the socket. If not, restore.

If the device is giving off light, but no heat, the heating bulb may be damaged. Contact the retailer to arrange a replacement unit.

9 | Warranty

The Ecostrad Sunglo is supported by a 2-year guarantee covering the heater body and all electronic components, including the bulb. Within the stated period, starting from the date the customer receives their unit, Ecostrad guarantee to repair or replace the unit where a fault is due to defects in materials or manufacturing.

The warranty does not cover any defect arising from damage, negligence, usage outside the product's intended purpose or fair wear and tear. The warranty is only valid when the unit has been operated in accordance with all conditions specified in this manual. The warranty will be void if the heater has been covered, used with an external controller, tampered with or opened in any way, or if the ratings label has been removed.

The warranty does not cover failures and faults due to force majeure, accidental damage, mishandling, transporting the device, external impact, chemical agents or atmospheric phenomena, incorrect use of the device, use of the device when dirty, faulty electrical installation on the part of the purchaser, or problems caused by the device being handled by persons not authorised by Ecostrad. Photographs of the installation may be required to determine correct placement. If the unit has been hardwired, an invoice may be required to confirm the work was carried out by a qualified professional. Ecostrad cannot accept responsibility for damage, loss or injury caused by incorrect installation, maintenance, cleaning or covering the device.

The warranty is a contract with the original purchaser and does not transfer if the unit is re-sold, gifted or inherited. Proof of purchase, including order number and order confirmation or invoice, will be required if a claim is made.

The warranty covers only the model of heater shown on the purchase invoice. The warranty covers the repair or replacement of the defective product only and Ecostrad shall have no liability for installation costs or consequential losses however incurred. The unit is sold as a DIY product; whilst hardwiring is permitted within the terms of the warranty – provided evidence can be produced that the work was performed by a qualified installer – no compensations will be offered for the installer's costs in the event of a claim.

Claims must be made with the establishment where the device was purchased. This warranty does not affect the customer's consumer rights.

10 | Disposal



The icon with the crossed-out waste bin on electrical or electronic equipment stipulates that this equipment must not be disposed of with household waste at the end of its life. You will find collection points for free return of waste electrical and electronic equipment in your vicinity. The addresses can be obtained from your local authority.

The separate collection of waste electrical and electronic equipment enables the re-use, recycling and other forms of recovery of waste equipment, and prevents any negative effects for the environment or human health caused by the disposal of hazardous substances potentially contained in the equipment.